



200-22574

DM 2020-11-441
DEPED MALAYBALAY CITY DIVISION
RELEASED
DATE: NOV 10 2020 4:14
BY: [Signature]

Republic of the Philippines
Department of Education
REGION X – NORTHERN MINDANAO
DIVISION OF MALAYBALAY CITY

Division MEMORANDUM

No. **441**, s. 2020

TO: Assistant Schools Division Superintendent
Chief Education Supervisor, SGOD and CID
Public Elementary and Secondary School Heads
Gulayan Sa Paaralan Coordinators
All Others Concerned

FROM: For the Schools Division Superintendent

ALIENA S. DAJAY, PhD, CESE
Asst. Schools Division Superintendent

DATE: November 10, 2020

**SUBJECT: DISSEMINATION OF DEPED TASK FORCE COVID-19
MEMORANDUM NO. 244 RE: GUIDELINES ON THE USE OF
SCHOOLS AS EVACUATION CENTERS IN CONSIDERATION OF THE
COVID-19 PANDEMIC**

The field is hereby informed of the DepEd Task Force COVID-19 Memorandum No. 244, s. 2020 re: Guidelines on the Use of Schools as Evacuation Centers in Consideration of the COVID-19 Pandemic. Its content is self-explanatory.

Widest dissemination of this memorandum is enjoined.

Encl: As stated

Copy Furnished: Records Unit | DRRM





Republika ng Pilipinas
Kagawaran ng Edukasyon
Tanggapan ng Pangalawang Kalihim

DepEd Task Force COVID-19
MEMORANDUM No. 244
05 November 2020

**For: Minister of Basic, Higher, and Technical Education, BARMM
Regional Directors
Schools Division Superintendents
Public School Heads
All Others Concerned**

**Subject: GUIDELINES ON THE USE OF SCHOOLS AS EVACUATION
CENTERS IN CONSIDERATION OF THE COVID-19
PANDEMIC**

The Department of Education (DepEd) Task Force COVID-19 reminds all concerned that **the use of DepEd schools as evacuation centers for families and individuals affected by natural and human-induced disasters shall continue to be guided by the *Children's Emergency Relief and Protection Act (RA 10821)* and COVID-19 minimum health standards.**

The following are specifically reiterated:

1. RA 10821 emphasizes that the establishment of evacuation centers which are safe, inclusive, child-friendly, and provide for gender-sensitive and responsive amenities is the responsibility of Local Government Units (LGUs). **A school may only be used as an evacuation center only as a last resort, or only in cases where there is no other available place or structure which can be used for the said purpose.** In cases where schools shall be used, the following shall be observed pursuant to RA 10821:
 - a. LGUs shall coordinate with the School Heads and respective Schools Division Superintendents (SDS) before schools may be used as temporary evacuation centers, and shall **execute a Memorandum of Agreement.**
 - b. Should the school be used, the LGU shall coordinate with the School Head and ensure that gymnasiums, learning and activity centers, auditoriums and other open spaces shall be utilized first; **classrooms shall only be used as a last resort.**



Office of the Undersecretary for Administration (OUA)

[Administrative Service (AS), Information and Communications Technology Service (ICTS), Disaster Risk Reduction and Management Service (DRRMS), Bureau of Learner Support Services (BLSS), Baguio Teachers Camp (BTC), Central Security & Safety Office (CSSO)]

Department of Education, Central Office, Meralco Avenue, Pasig City
Rm 519, Mabini Bldg; Mobile: +639260320762; Tel: (+632) 86337203, (+632) 86376207
Email: usec.admin@deped.gov.ph; Facebook/Twitter @depeditayo



Scan this QR Code to view
videos and Magazines
of Major Programs



- c. School personnel shall focus on providing education services, particularly education continuity for children in affected communities; **they shall not be assigned as camp managers.**

Following DepEd policy, school personnel and members of the DRRM Teams in schools designated as evacuation centers may be requested to render service even when classes and/or work are suspended only for the purpose of monitoring the school facilities and resources, subject to strict compliance to COVID-19 health measures.

In view of the emergency response services rendered during the period of work cancellation/suspension, concerned personnel shall be entitled to service credits pursuant to DepEd Order No. 53, s. 2003, and/or overtime payment subject to policy and guidelines set by the Civil Service Commission and the Department of Budget and Management.

- d. When necessary, **the use of school premises shall be as brief as possible.** It shall only be up to three (3) days for short-term displacement, fifteen days for medium and long-term displacement, or until such time that the respective LGUs are able to establish alternative transitional sites.
- e. **If the use is predicted to exceed fifteen days, the affected LGU shall provide written documentation** to the DepEd and the Department of the Interior and Local Government (DILG) on the following:
- i. The name and location of the school;
 - ii. All alternative evacuation centers, transitional relocation sites, and/or permanent relocation sites for final selection;
 - iii. Measures being implemented to prevent interference or disruption to the school and educational activities of children;
 - iv. Timeline for the relocation of and plan of action for internally displaced persons to sites outside of schools shall be approved by DepEd.
- f. The Regional or Division Office of DepEd, assisted by the Department of Public Works and Highways (DPWH), the Local Engineering Office, and the Bureau of Fire Protection (BFP) shall **conduct regular site inspection of public schools to ensure the stability of structures for the safety of children and their environment.** A report on the inspection shall be submitted to the Secretary of DepEd, copy furnished the Local Chief Executive, for the purpose of repair of the damaged school being used as an evacuation center.
- g. **The LGU is responsible for facilitating general cleaning, fumigation, payment of utilities, and repair of schools used as evacuation centers.** Damages incurred by schools used as evacuation



centers shall be immediately reported by their respective School Heads to the LGU for appropriate action. Repairs and/or replacement of damaged facilities and materials of damages to schools used as evacuation centers shall be immediately undertaken to ensure the safety and well-being of internally displaced persons. Such repairs and replacement shall be monitored by the School Head and SDS in coordination with the LGU. LGUs shall also provide clean-up kits.

2. In consideration of the COVID-19 Pandemic, a school may only be considered for use as an evacuation center if:
 - a. The **school is not currently being used as a COVID-19 quarantine or isolation facility**, following OM-OSEC-2020-002, -003, -004, and -005.
 - b. The **disinfection of the school has been completed** after its use as a quarantine or isolation facility.
 - c. The LGU concerned is able to ensure that **all applicable and required health standards are adhered to in the set-up and operation of the school to be used as an evacuation center of last resort**, as evidenced by a certification from the local Inter-Agency Task Force on Emerging Infectious Diseases (IATF).
3. Finally, the findings of the Office of the Undersecretary for Administration first released through an Aide Memoire dated 04 May 2020 (*please see attached*) that **the design specifications of the ceilings of school buildings constructed from 2014 to 2019 were apparently not followed in actual construction** is reiterated. DepEd is currently in the direction of replacing the existing ceilings of school buildings, specifically those that were constructed from 2014 onwards.

As a preventive measure against any untoward incident, all are advised to **refrain from using single-story school buildings, and the top floors of multi-story school buildings for evacuation purposes.**

For all future correspondence and queries on this subject, please contact the Disaster Risk Reduction and Management Service (DRRMS) through telephone number (02) 8637-4933 and email at drmo@deped.gov.ph ; or Mr. Jeonoh Kali Fornoles, Senior Technical Assistant II of the said office via email at jeonoh.fornoles@deped.gov.ph .

For immediate and appropriate action.



OUAD00-1120-0076
To authenticate this document
please scan the QR Code



ALAIN DEL B. PASCUA

Undersecretary

Chairperson, DepEd Task Force COVID-19





Republika ng Pilipinas
Kagawaran ng Edukasyon
Tanggapan ng Pangalawang Kalihim

AIDE MEMOIRE
4 May 2020

**URGENT NEED TO REPAIR AND REPLACE
CEILING OF SCHOOLBUILDINGS
CONSTRUCTED BY FROM 2014-2019**

I. BACKGROUND

In 2014, right after the devastating Super Typhoon Yolanda a big number of school buildings sustained major damage particularly the roofing and its other components. With this, **the DepEd, together with Department of Public Works and Highways - Bureau of Designs (DPWH-BOD), and the assistance of the Japan International Cooperation Agency (JICA), conducted an intensive review of existing school building designs and upgraded** them to conform with the latest National Building Code (NBC) and National Structural Code of the Philippines (NSCP). **The upgraded School Building Designs were then issued by the DPWH and were conformed with by DepEd.**

The upgraded designs were made **to withstand 340 kph wind velocity** in areas located in the Eastern Seaboard (Zone 1) **and 270 kph** for rest of the areas in the country (Zone 2). They were also designed **to sustain up to magnitude 8 earthquake**. The upgraded designs include the adoption of **metal furring and fiber cement board** to be used for the suspended type ceiling.

II. CEILING DESIGN

Before 2014, DepEd already adopted the use of suspended ceilings in its standard School Building Designs composed of wooden materials specifically 50mm X 50mm ceiling hangers and ceiling joists spaced at 600mm with ordinary and marine Plywood ceiling (see picture below). The use of wood has several advantages: unlike metal, wood does not conduct heat and this increases thermal comfort or classrooms cooler; plywood, unlike ficem boards, is definitely easier to work with especially when cutting manholes (or handholes) for future utility main access inside ceiling (*kisame*).



Office of the Undersecretary for Administration (OUA)

Administrative Service (AS), Information and Communications Technology Service (ICTS), Disaster Risk Reduction and Management Service (BLSS), Bureau of Learner Support Services (BLSS), Baguio Teachers' Camp (BTC), Central Security & Safety Office (CSSO)

Department of Education, Central Office, Meralco Avenue, Pasig City
Rm 519, Mabini Bldg; Mobile: +639260320762; Tel: +63286337203, +63286376207
Email: usec.admin@deped.gov.ph; Facebook/Twitter @depedtayo



Scan this QR Code to view
Videos and Magazines
of Major Programs

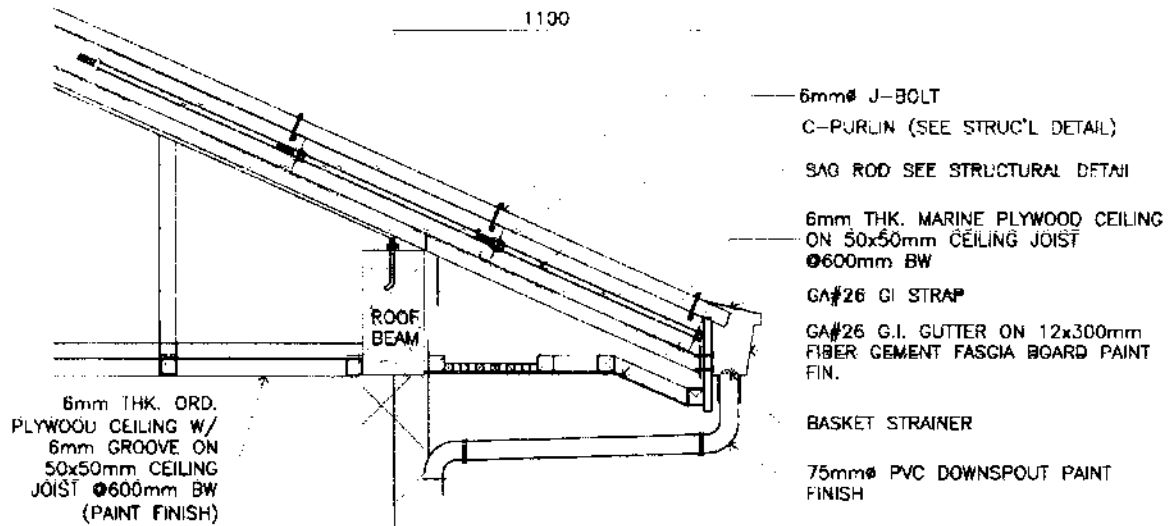

SUSPENDED CEILING TYPE
CEILING DETAIL

NOT TO SCALE

When **DPWH** reviewed the designs of the school buildings in **2014**, the materials used for the ceiling was changed from the conventional wooden type ceiling hangers and joists and marine plywood, to metal furring and fiber cement ceiling board. It can be clearly seen in the design drawings that the spacing of metal furring is set at 400mm X 400mm, using metal carrying C-channels.

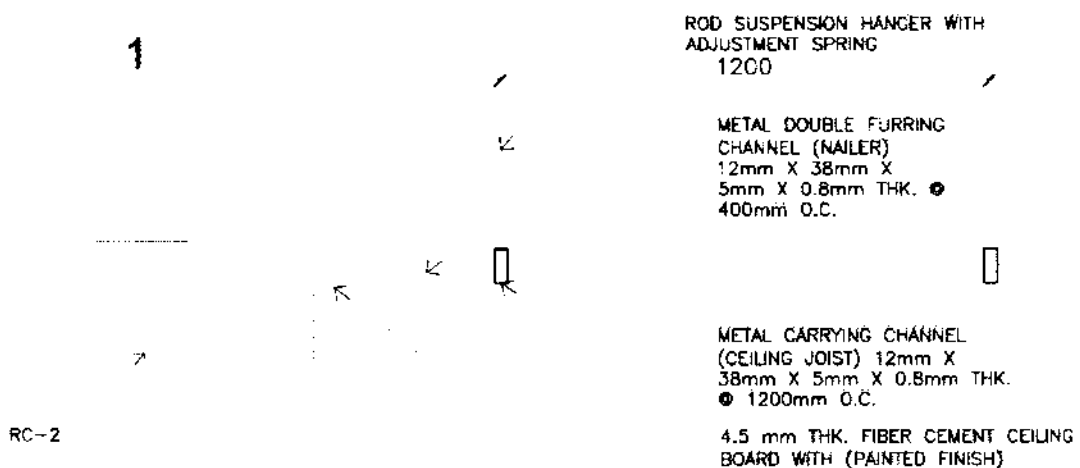

SECTION

NOT TO SCALE



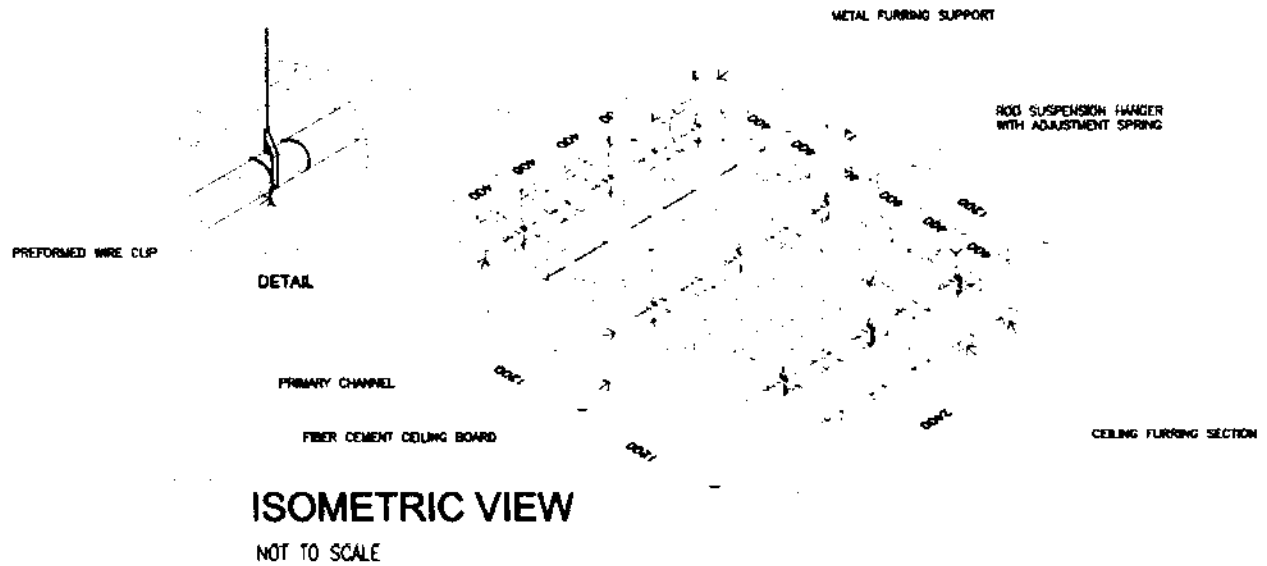

The design specifications were apparently not followed in actual construction: not only were metal C-channels spaced farther apart, there was inadequate and fewer metal furring supports/hangers, as evidenced in the pictures of collapsed ceilings shown in the succeeding pages of this document.

III. INCIDENTS OF COLLAPSED CEILINGS

The first incident of collapsed ceiling was reported in Ramon de Santos NHS, Cuyapo, Nueva Ecija. The incident happened in November 2017 under normal weather condition. The said incident was broadcasted in local media outfits which led the DPWH contractor to shoulder the expenses of hospitalization and medicines of injured students and the reconstruction of the collapsed ceiling without any additional cost to the government.



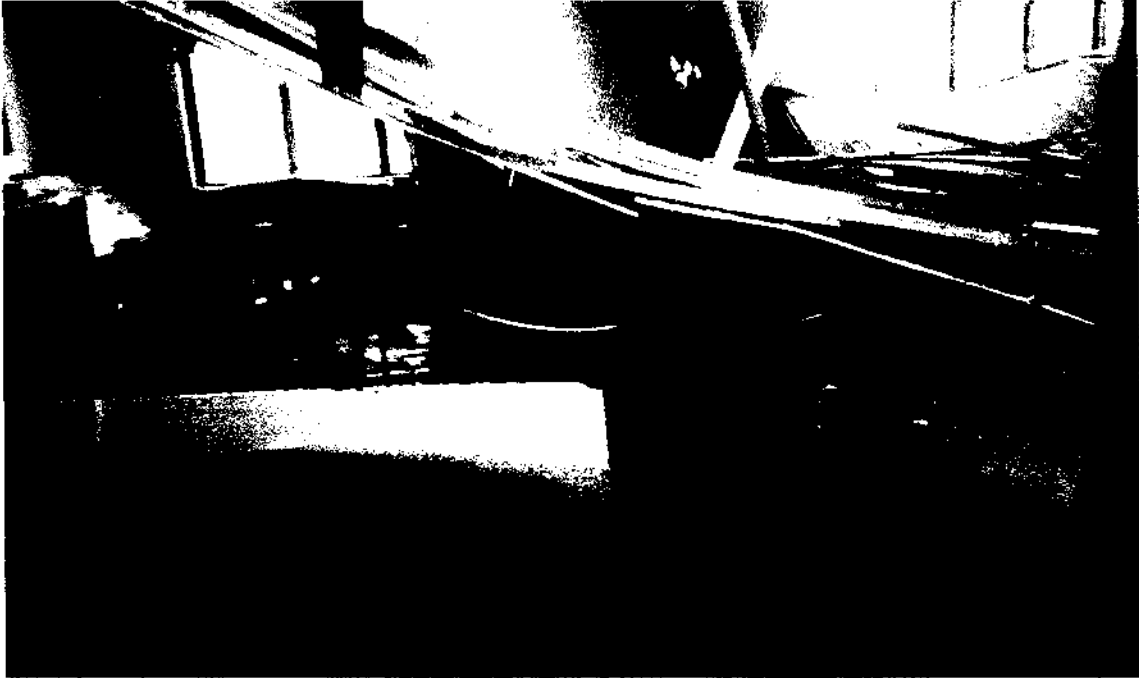

Several incidents followed and were recorded by the Regional and Division Offices of DepEd particularly after a series of earthquakes and other natural calamities struck the country.

Domingo Lacson National High School



Collapsed Ceilings due to Earthquakes

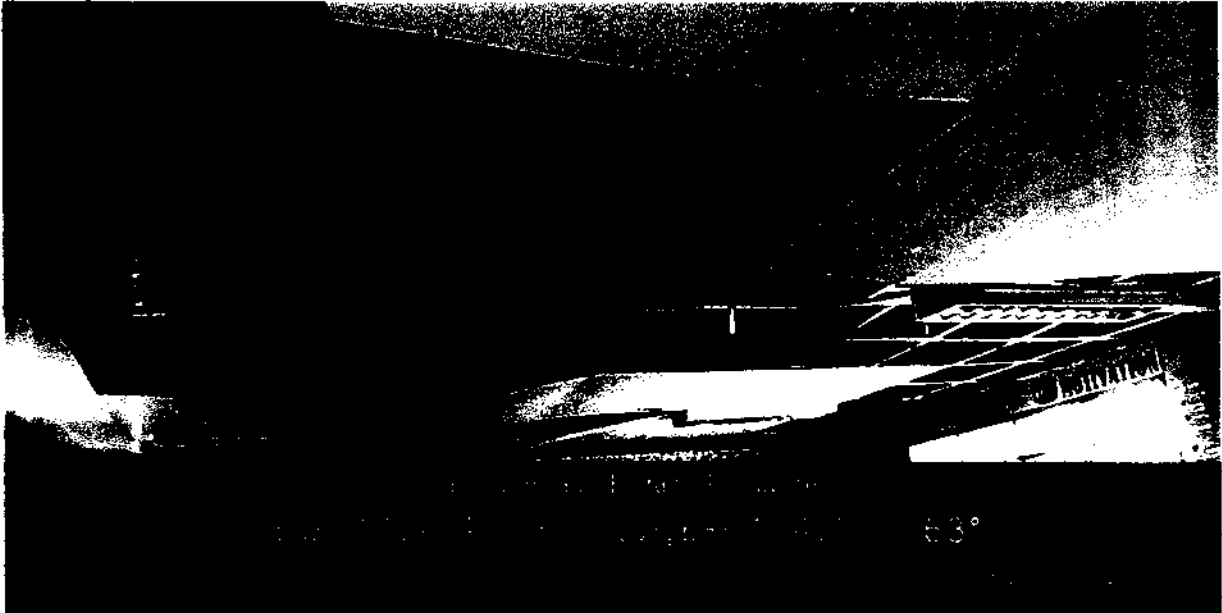

Collapsed Ceiling due to Typhoons

Matacon NHS, Albay collapsed ceiling due to Typhoon Tisoy

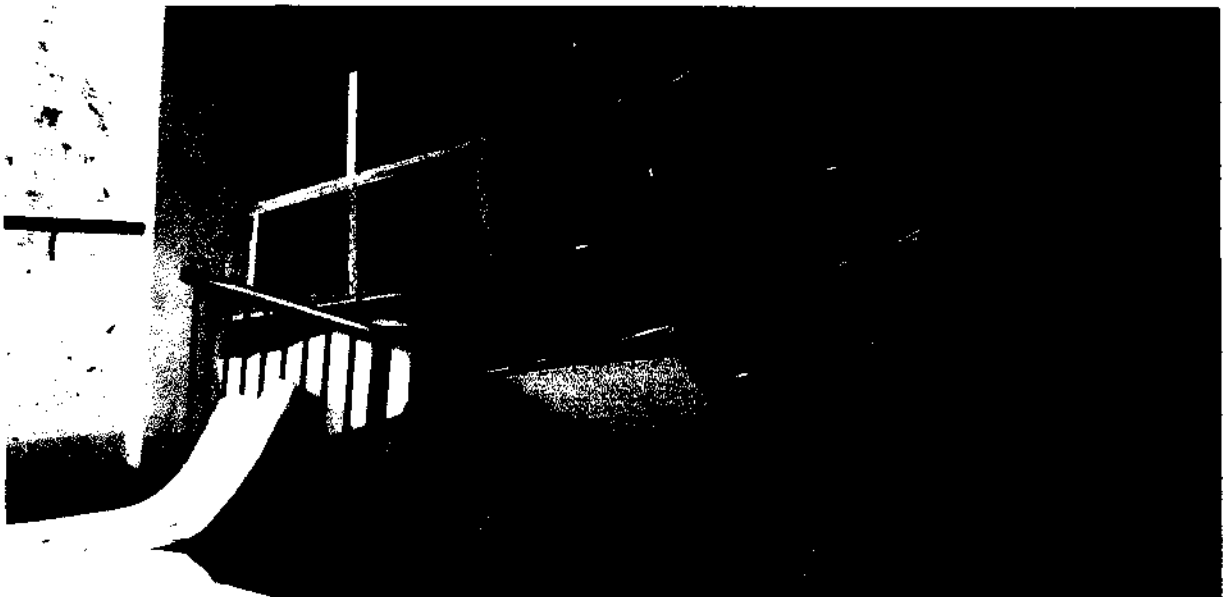



IV. Proposed Remedial Actions

The increasing number of incidents related to collapsed ceilings of school buildings have raised concerns on the safety of our learners and school personnel. Thus, efforts have been made by DepEd to immediately address this concern.

a. Revision of Designs

In July 3, 2019 letter of DepEd to DPWH, the former requested a thorough review of the current ceiling designs of the school buildings to include the material specifications and the methodology of construction.

In the reply of the DPWH-Bureau of Designs dated December 12, 2019, they said that there are no revisions needed in the designs since **the reported incidents were due to improper construction or improper use of materials and construction methodology** other than those in the standard designs and specifications. This conclusion was based on investigations they conducted on the affected projects. Attached are copies of DepEd letter dated July 3, 2019 and the reply of DPWH-Bureau of Designs dated December 12, 2019.

However, **the series of earthquakes that happened in Cotabato, Surigao, Davao, Batanes; of typhoons Ursula, Tisoy, Dodong, Usman, Amang, Vinta, etc.; and the Taal eruption all resulted to collapsed ceilings as regular featured damages.** Had there been classes during those times, the injuries of learners and teachers would have been enormous.

b. Reporting of incidences of collapsed ceiling to DPWH for proper remedial action

Incidences of collapsed ceilings are being reported to the DPWH Central Office for immediate and proper action. **For those projects that are still under warranty, contractors of DPWH were instructed to immediately replace damaged ceilings without any additional cost to the government.**

However, **for projects past or beyond their warranty period, DepEd initiates the removal of damaged ceilings, and the affected buildings are considered for programming in the regular repair/rehabilitation program** of the Department.

c. Implementation of the Revised Designs of Ceilings

While the DPWH stands that there is no need to revise the design of the ceiling of the school buildings, DepEd—in giving top priority to the safety of its learners and school personnel—is in the direction of **replacing the**

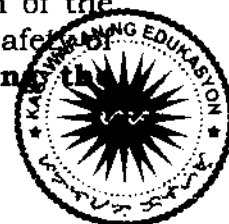

existing ceilings of school buildings specifically those that were constructed from 2014 onwards.

In the implementation, the Department will be **using the conventional materials such as ordinary and marine plywood on wooden joist** as shown in the drawings below.

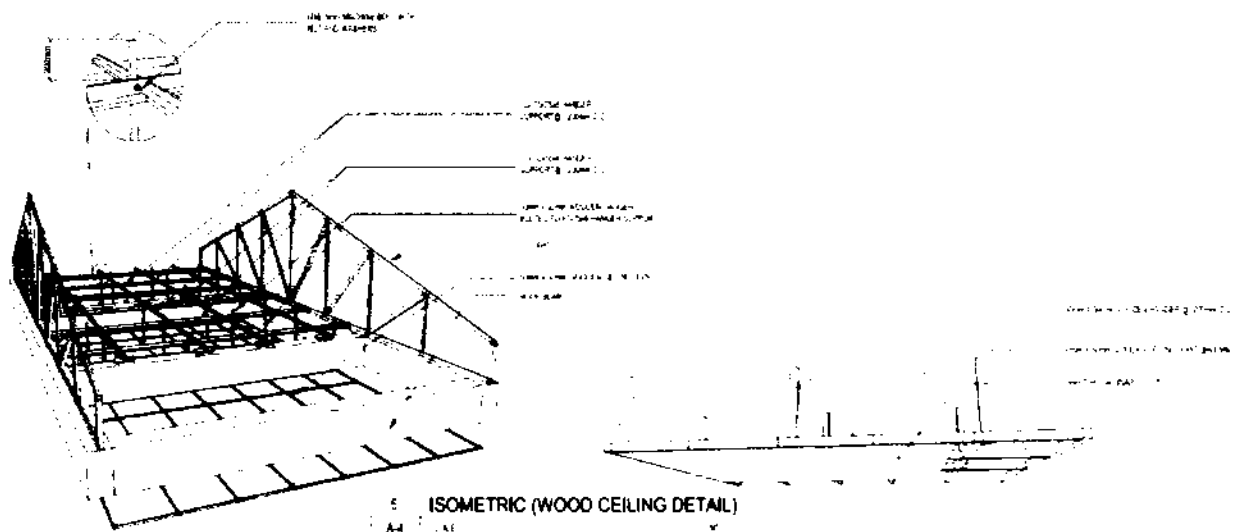

The total estimated cost for replacing the ceiling of one classroom is P117,000.00 which includes labor, and other related taxes and overhead cost.

Based on consolidated data of the Education Facilities Division (EFD), from 2014-2019, a total of about 34,908 school buildings were constructed using the new ceiling design. Of this, **469 school buildings were reported to have damaged or collapsed ceilings due to various calamities occurring on those areas where the schools are located**. The replacement of some of these ceilings is already part of the programs made by the EFD in the repair of calamity-damaged school buildings under the Quick Response Fund (QRF) amounting to P221M.

However, **as a preventive measure for any untoward occurrence or accidents, the Department is initiating to replace the ceilings of all classrooms constructed from 2014-2019**. This will cover the remaining **34,439 school buildings with an equivalent 98,290 classrooms**. All said, this would require an estimated budget of P11.5 billion.

The ceiling replacement in the 34,439 school buildings is of utmost importance as **the collapse of the ceilings is very imminent at the instant occurrence of earthquakes and typhoons**. The series of earthquakes and typhoons in 2019 and 2018 have proven this to be so.



The Department is planning to implement this as soon as possible. Specifically, it hopes to start the project immediately once the ECQ is lifted and to complete the repair of ceilings before August 24, for the possible return to regular schooling.

ALAIN DEL B. PASCUA
Undersecretary



QUAD00-0520-000 2
To authenticate this document
please scan the QR Code